



MODEL KH-932

TR 5

B	-4.65V(-4.7V)
C	-1.8V(-1.65V)
E	-5.5V(-5.5V)

TR 4

B	-4.85V(-4.9V)
C	-1.08V(-1.21V)
E	-5.78V(-5.78V)

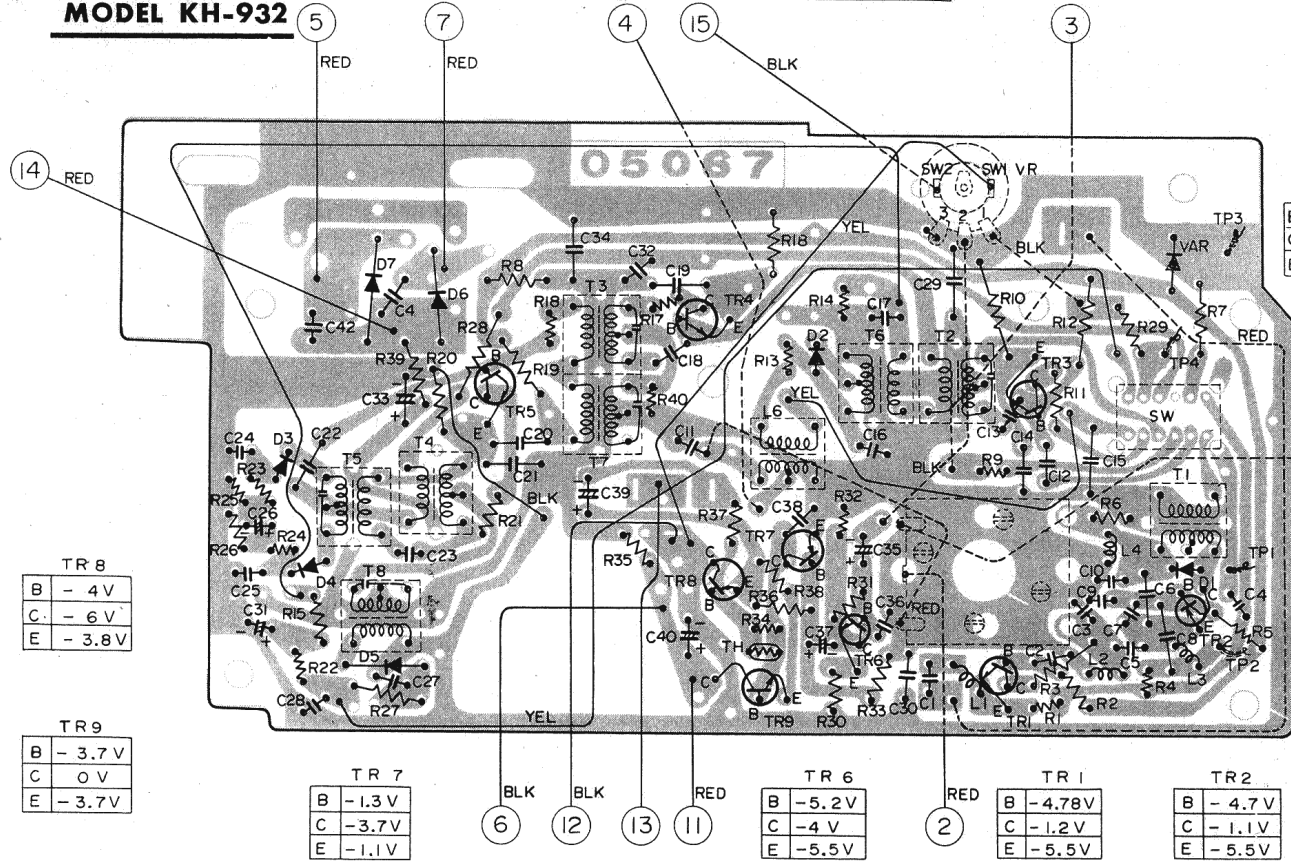

TR 8

B	-4V
C	-6V
E	-3.8V

TR 9

B	-3.7V
C	0V
E	-3.7V

TR 7

B	-1.3V
C	-3.7V
E	-1.1V

TR 6

B	-5.2V
C	-4V
E	-5.5V

TR 1

B	-4.78V
C	-1.2V
E	-5.5V

TR 2

B	-4.7V
C	-1.1V
E	-5.5V

TR 3

B	-4.7V(-4.65V)
C	-1.7V(-1.5V)
E	-5.5V(-5.4V)

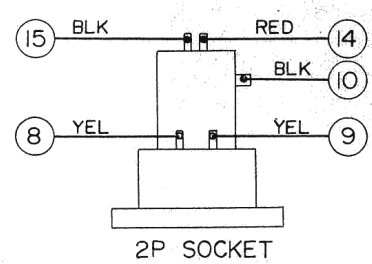
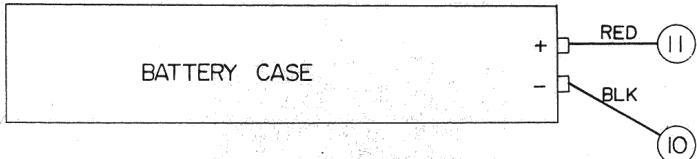
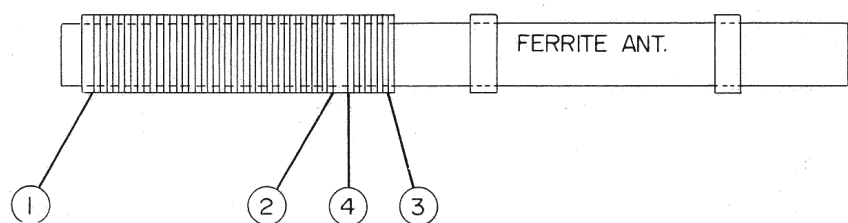
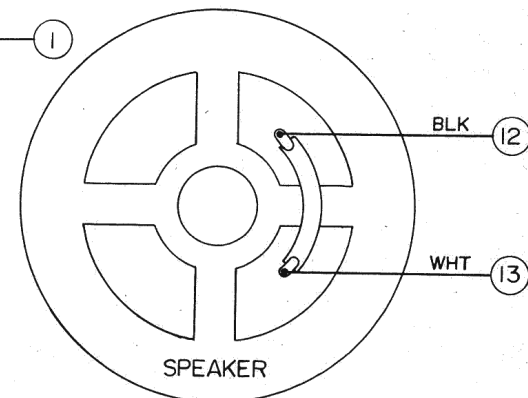
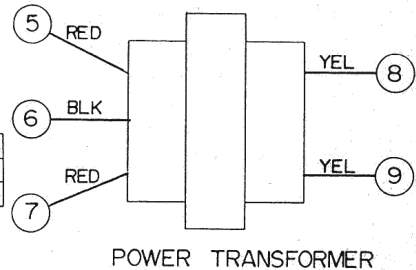

TR1
2SC461
FM RF AMP.

TR2
2SC535
FM CONV.

D1
IN60
FM LIMITER

VAR
HV-46
VOLTAGE
STABILIZER

TR3
2SC460
FM IF AMP.
&
AM CONV.

D2
IN60
AGC

TR4, TR5
2SC454 x 2
FM/AM IF AMP.

D5
IN34A
AM DET.

D3, D4
IN60P x 2
FM DISC.



MODEL KH-932

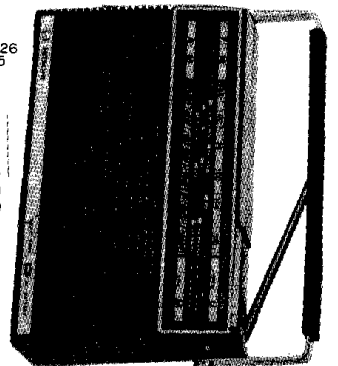
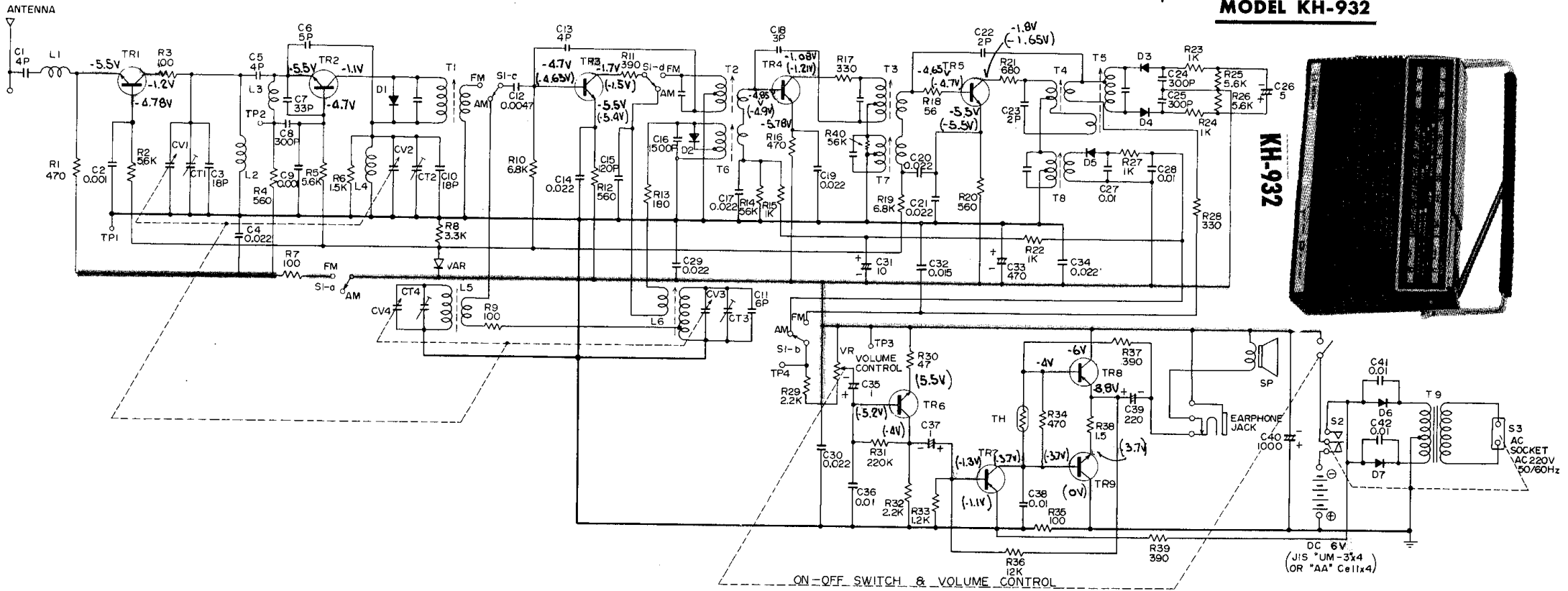

KH-932

TR6 2SC458 AF AMP.	TR7 2SB75 AF AMP.	TH D-IE TEMPERATURE COMPENSATOR	TR8 2SB77 POWER AMP.	TR9 2SD77 POWER AMP.	D6, D7 V06B x 2 RECTIFIER
--------------------------	-------------------------	--	----------------------------	----------------------------	---------------------------------